

Signet 2839-1V to 2842-1V PVDF Conductivity Electrodes



3-2840.090-1 Rev. 3 08/19

Operating Instructions

Table of Contents

2839: 0.01 cm⁻¹ 2840: 0.1 cm⁻¹



**2841: 1.0 cm⁻¹
2842: 10.0 cm⁻¹**



Warranty Information	2
Product Registration	2
Safety Information.....	2
Specifications.....	3
Dimensions	3
Cell Constant Selection	4
Custom Cell Certificate	4
Installation.....	4
In-Line Installation.....	4
Submersible Installation.....	5
Integral Installation.....	5
General Wiring.....	6
ProcessPro Wiring	6
SmartPro Wiring	6
Maintenance	7
2842 Insulator	7
Ordering Information.....	8



- [English](#)
- [Deutsch](#)
- [Français](#)
- [Español](#)
- [中文](#)



Warranty Information

Refer to your local Georg Fischer Sales office for the most current warranty statement.

All warranty and non-warranty repairs being returned must include a fully completed Service Form and goods must be returned to your local GF Sales office or distributor. Product returned without a Service Form may not be warranty replaced or repaired.

Signet products with limited shelf-life (e.g. pH, ORP, chlorine electrodes, calibration solutions; e.g. pH buffers, turbidity standards or other solutions) are warranted out of box but not warranted against any damage, due to process or application failures (e.g. high temperature, chemical poisoning, dry-out) or mishandling (e.g. broken glass, damaged membrane, freezing and/or extreme temperatures).

Product Registration







Thank you for purchasing the Signet line of Georg Fischer measurement products.

If you would like to register your product(s), you can now register online in one of the following ways:

- Visit our website **www.gfsignet.com**. Under **Service and Support** click on **Product Registration Form**
- If this is a pdf manual (digital copy), [click here](#)

Safety Information

1. Depressurize and vent system prior to installation or removal.
2. Confirm chemical compatibility before use.
3. Do not exceed maximum temperature/pressure specifications.
4. Wear safety goggles or faceshield during installation/service.
5. Do not alter product construction.
6. When using chemicals or solvents care should be taken and appropriate eye, face, hand, body, and/or respiratory protection should be used.

	Caution / Warning / Danger Indicates a potential hazard. Failure to follow all warnings may lead to equipment damage, injury, or death
	Electrostatic Discharge (ESD) / Electrocutation Danger Alerts user to risk of potential damage to product by ESD, and/or risk of potential of injury or death via electrocution.
	Personal Protective Equipment (PPE) Always utilize the most appropriate PPE during installation and service of Signet products.
	Pressurized System Warning Sensor may be under pressure, take caution to vent system prior to installation or removal. Failure to do so may result in equipment damage and/or serious injury.
	Hand Tighten Only Overtightening may permanently damage product threads and lead to failure of the retaining nut.
	Do Not Use Tools Use of tool(s) may damage product beyond repair and potentially void product warranty.
	Note / Technical Notes Highlights additional information or detailed procedure.

Specifications

General

Instrument Compatibility2850, 8850-3, 8860, 9900

Cable

4.6 m (15 ft) std., 3 conductor with shield, 22 AWG,
max length 30 m (100 ft). For resistivity measurements above
10 MΩ or below 20 °C, maximum cable length is 7.6 m (25 ft).

Process Connection

-1V³/₄ in. NPT
-1VD.....ISO 7/1-R ³/₄

Wetted materials

Threaded fitting.....PVDF
Insulator.....PVDF
Insulator O-ring (2841, 2842) ...FKM
Electrode contacts.....316L stainless steel

Shipping Weight

2839.....0.34 kg (0.74 lb)
2840, 2841, 2842.....0.30 kg (0.66 lb)

Performance

Accuracy.....±2% of cell value
Temp. measurement.....PT1000
Temp. response time (T):
2839.....5 s
2840.....10 s
2841.....20 s
2842.....30 s

Operating Pressure / Temperature

With thread engagement per ANSI B1.20.1

-10 °C to 100 °C @ 6.9 bar (14 °F to 212 °F @ 100 psi)
-10 °C to 131 °C @ 2.76 bar (14 °F to 268 °F @ 40 psi)

Storage Temperature.....-20 °C to 131 °C
(-4 °F to 268 °F)

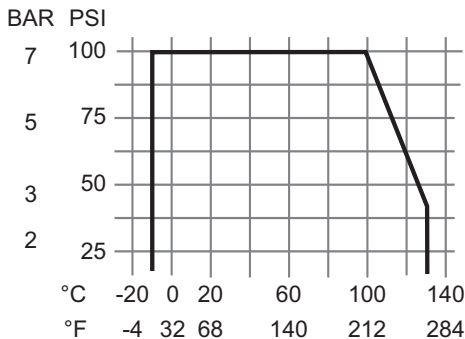

Standards and Approvals

- Manufactured under ISO 9001 for Quality, ISO 14001 for Environmental Management and OHSAS 18001 for Occupational Health and Safety.
- RoHS Compliant
-  China RoHS (Go to www.gfsignet.com for details)

Dimensions

2839: 0.01 cm⁻¹

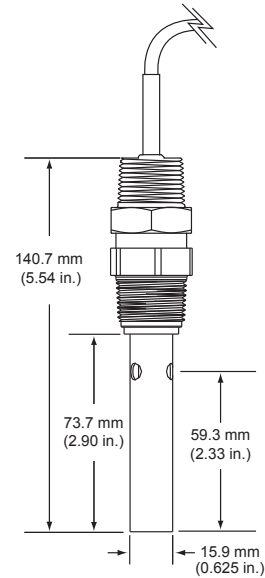

2840: 0.1 cm⁻¹

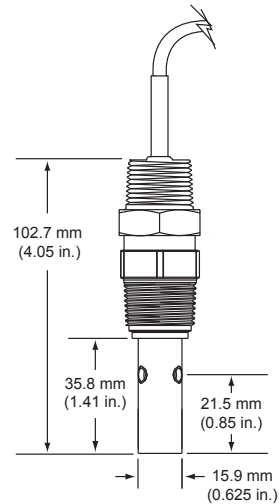

2841: 1.0 cm⁻¹ 2842: 10.0 cm⁻¹

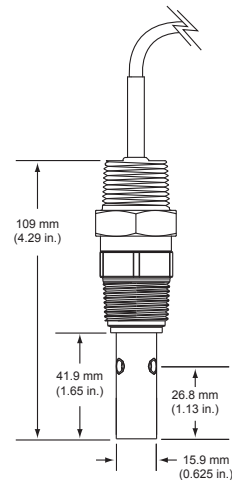

Cell Constant Selection

The nominal process value should be near the center of the range. Ranges below are for use with Signet Conductivity Instruments:

- 2839 (0.01 cm⁻¹): 0.010 to 100 μS (10 kΩ to 100 MΩ)
- 2840 (0.1 cm⁻¹): 1 to 1000 μS (1 MΩ to 1 kΩ)
- 2841 (1.0 cm⁻¹): 10 to 10,000 μS
- 2842 (10.0 cm⁻¹): 100 to 200,000 μS

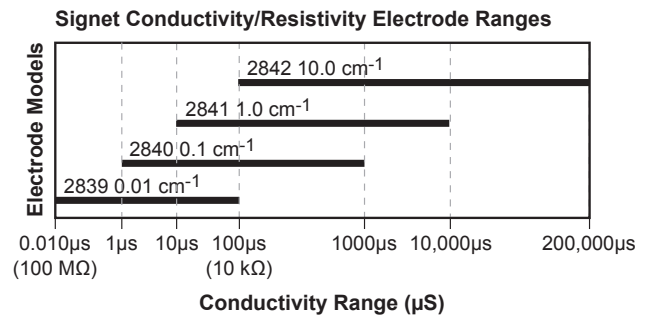

Custom Cell Certificate

The sensor was delivered from the factory with a calibration certificate. The information provided on the certificate (custom cell constant and temperature offset) should be entered in the transmitter/controller. See individual product manual for details.

Installation

- Inspect threads to ensure integrity. Do not install an electrode with damaged threads.
- Apply sealant or PTFE tape to threads.
- Wetted materials include 316L stainless steel, PVDF and FKM (FKM O-ring inside 2841, 2842). Check for chemical compatibility before installing electrode.
- Electrodes are supplied with 4.6 m (15 ft) of cable. It may be extended to a maximum 30 m (100 ft).
- For resistivity measurements above 10 MΩ or below 20 °C, maximum cable length is 7.6 m (25 ft).
- When using the 2850 Conductivity/Resistivity Sensor Electronics, maximum cable length is 4.6 m (15 ft).
- When using 9900, maximum cable length is 30 m (100 ft).

In-Line Installation

If the electrode is mounted vertically in a tee, do not recess the openings inside the tee. Mounting upside down may help prevent air entrapment.

An oversized tee may also be helpful for inline installations.

At least 4 threads (ANSI B1.20.1) must be engaged to provide pressure capacity per published specifications.

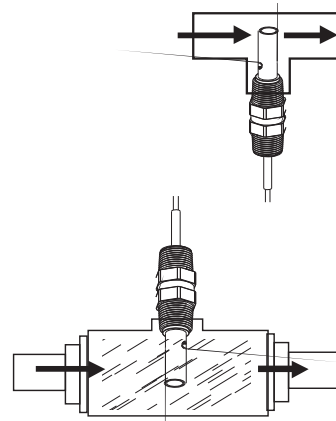
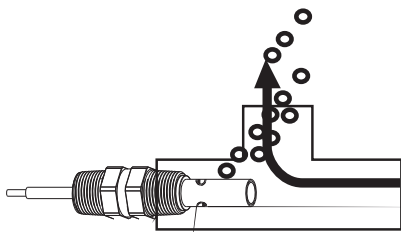

The preferred installation for in-line applications directs flow straight into the electrode.

This configuration dislodges entrapped air bubbles, and provides the best continuous sampling of the fluid content.

Submersible Installation

1. Feed cable into watertight conduit.
2. Apply thread sealant to the electrode before threading conduit onto electrode. Avoid twisting the cable.
3. Secure cable with conduit or cable gland.
4. For additional defense against possible accumulation of condensation at the back seal area of the electrode, fill the lower 75 mm to 100 mm (3 in. to 4 in.) of conduit or extension pipe with a flexible sealant such as silicone.



$\frac{3}{4}$ in. NPT or
ISO 7/1-R $\frac{3}{4}$

In aerated vessels install the electrode in a stillwell to prevent air from being trapped inside the electrode.

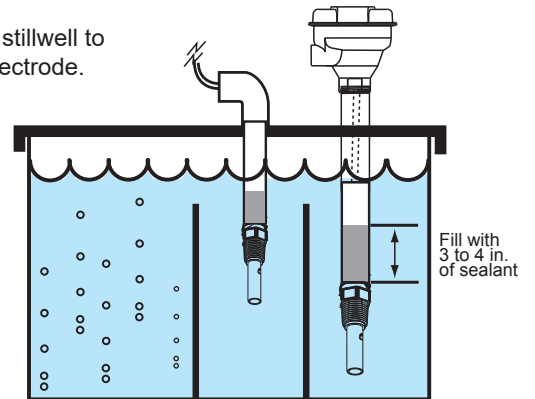
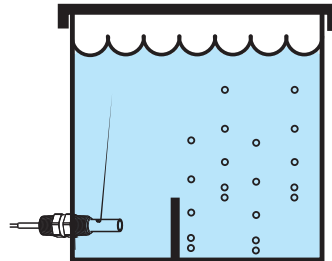

Integral Installation

- 3-8052 Integral Kit and 3-9000.392-X Liquid Tight Connector kit are required. (See Parts and Accessories on back page).
- Cut the cable to approx. 15 cm (6 in.).
- Strip outer cable cover back 5 cm (2 in.).
- Strip each conductor to expose 1 cm ($\frac{3}{8}$ in.) of bare wire.
- Tin each conductor with solder for best results.

9900-1 Field Mount
with 8052 Integral Mounting Kit
and 9900.396 Angle Adjustment Adapter

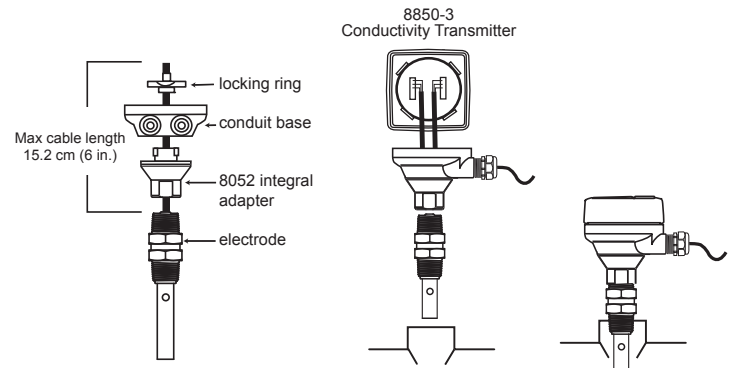
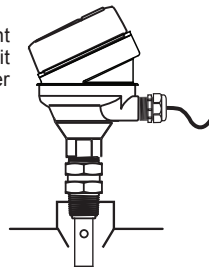

General Wiring

- Do not route electrode cable in conduit containing AC power wiring. Electrical noise may interfere with electrode signal.
- Routing electrode cable in grounded metal conduit will help prevent electrical noise and mechanical damage.
- Seal cable entry points to prevent moisture damage.
- For resistivity measurements above 10 MΩ or below 20 °C, maximum cable length is 7.6 m (25 ft).

ProcessPro Wiring

To 8850-3

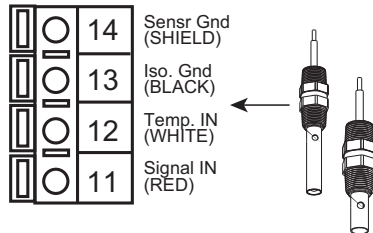

To 8860

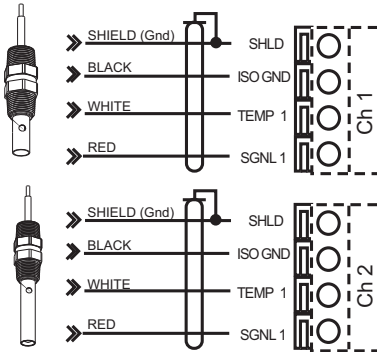

SmartPro Wiring

9900-1 Field Mount
with 8052 Integral Mounting Kit
and 9900.396 Angle Adjustment Adapter

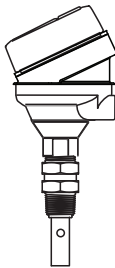

9900.394
Direct Conductivity/Resistivity Module
Input Connector

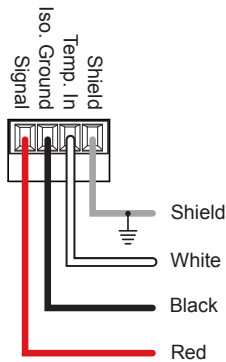

via 2850 Sensor Electronics

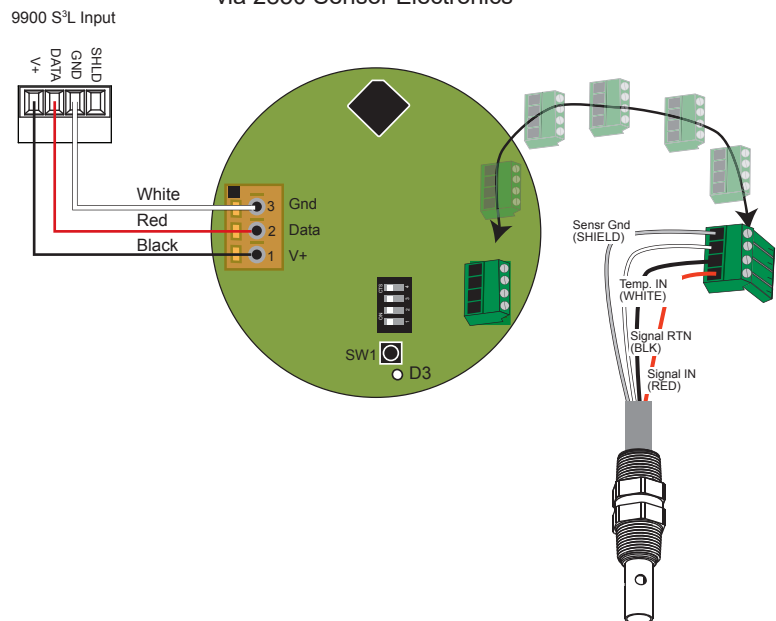

Maintenance

Conductivity electrodes require little maintenance except for periodic cleaning in installations where contaminants are present.

- Keep metal surfaces clean and free of coatings.

2842 Insulator

Replacement Insulator, 2842 electrode only

- 2842 electrodes have a removable insulator so the internal cavity can be cleaned.
- After the insulator snaps into position it cannot be removed without damage.
- Order insulator replacement kit 3-2842.390 before attempting maintenance.

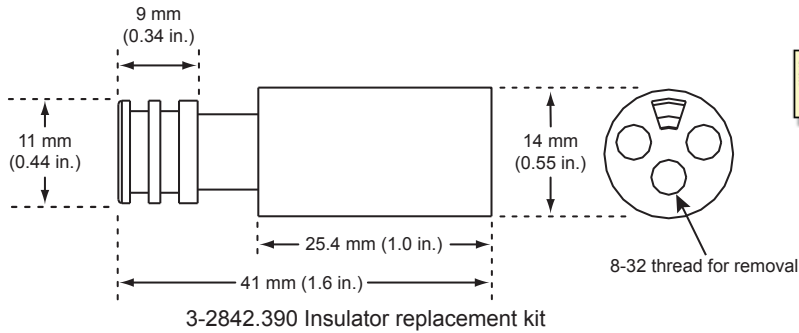

NOTE:

Contact the manufacturer for replacement part number and cost.

Insulator removal and replacement

- Thread the screw into the insulator (8-32 thread).
- Pull to remove the old insulator.
- Clean any coating or deposits inside the electrode.
- Insert the new insulator and press into place.

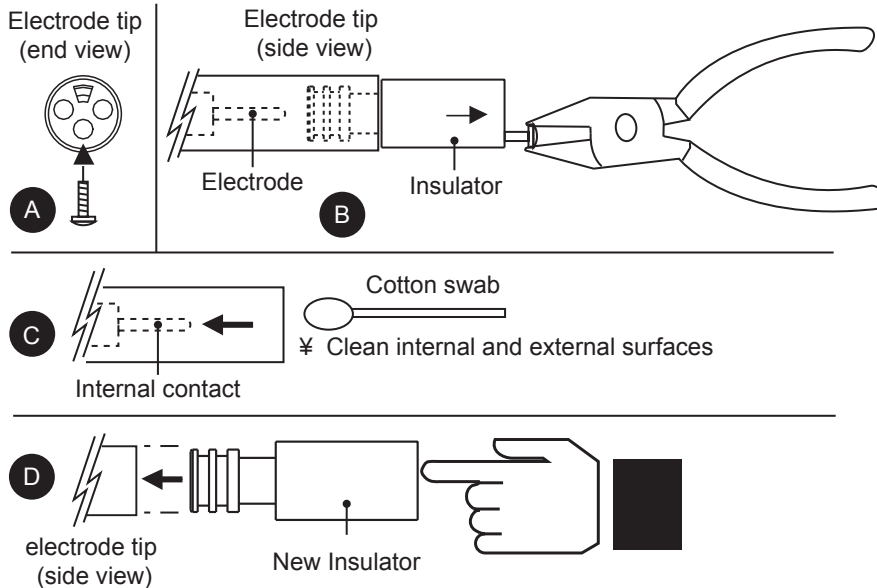

Ordering Information

PVDF Conductivity Electrodes

Mfr. Part No.	Code	Description
3-2839-1V	159 001 810	Cell 0.01, 4.6 m (15 ft) cable, PVDF NPT threaded fitting
3-2839-1VD	159 001 811	Cell 0.01, 4.6 m (15 ft) cable, PVDF ISO threaded fitting
3-2840-1V	159 001 812	Cell 0.1, 4.6 m (15 ft) cable, PVDF NPT threaded fitting
3-2840-1VD	159 001 813	Cell 0.1, 4.6 m (15 ft) cable, PVDF ISO threaded fitting
3-2841-1V	159 001 814	Cell 1.0, 4.6 m (15 ft) cable, PVDF NPT threaded fitting
3-2841-1VD	159 001 815	Cell 1.0, 4.6 m (15 ft) cable, PVDF ISO threaded fitting
3-2842-1V	159 001 816	Cell 10.0, 4.6 m (15 ft) cable, PVDF NPT threaded fitting
3-2842-1VD	159 001 817	Cell 10.0, 4.6 m (15 ft) cable, PVDF ISO threaded fitting

2850 Conductivity/Resistivity Sensor Electronics

3-2850-51	159 001 398	Sensor Electronics, 3/4 in. NPT j-box, one input/one Digital (S ³ L) output
3-2850-52	159 001 399	Sensor Electronics, 3/4 in. NPT j-box, one input/one 4 to 20 mA output
3-2850-61	159 001 400	Sensor Electronics, Universal Mount j-box, one input/one Digital (S ³ L) output
3-2850-62	159 001 401	Sensor Electronics, Universal Mount j-box, one input/one 4 to 20 mA output
3-2850-63	159 001 402	Sensor Electronics, Universal Mount j-box, two inputs/two Digital (S ³ L) outputs
3-2850-51-39V	159 001 818	Integral 2850 system, Digital (S ³ L) output, 0.01 cell, PVDF NPT threads
3-2850-51-40V	159 001 819	Integral 2850 system, Digital (S ³ L) output, 0.1 cell, PVDF NPT threads
3-2850-51-41V	159 001 820	Integral 2850 system, Digital (S ³ L) output, 1.0 cell, PVDF NPT threads
3-2850-51-42V	159 001 821	Integral 2850 system, Digital (S ³ L) output, 10 cell, PVDF NPT threads
3-2850-51-39VD	159 001 822	Integral 2850 system, Digital (S ³ L) output, 0.01 cell, PVDF ISO threads
3-2850-51-40VD	159 001 823	Integral 2850 system, Digital (S ³ L) output, 0.1 cell, PVDF ISO threads
3-2850-51-41VD	159 001 824	Integral 2850 system, Digital (S ³ L) output, 1.0 cell, PVDF ISO threads
3-2850-51-42VD	159 001 825	Integral 2850 system, Digital (S ³ L) output, 10 cell, PVDF ISO threads
3-2850-52-39V	159 001 826	Integral 2850 system, 4 to 20 mA output, 0.01 cell, PVDF NPT threads
3-2850-52-40V	159 001 827	Integral 2850 system, 4 to 20 mA output, 0.1 cell, PVDF NPT threads
3-2850-52-41V	159 001 828	Integral 2850 system, 4 to 20 mA output, 1.0 cell, PVDF NPT threads
3-2850-52-42V	159 001 829	Integral 2850 system, 4 to 20 mA output, 10 cell, PVDF NPT threads
3-2850-52-39VD	159 001 830	Integral 2850 system, 4 to 20 mA output, 0.01 cell, PVDF ISO threads
3-2850-52-40VD	159 001 831	Integral 2850 system, 4 to 20 mA output, 0.1 cell, PVDF ISO threads
3-2850-52-41VD	159 001 832	Integral 2850 system, 4 to 20 mA output, 1.0 cell, PVDF ISO threads
3-2850-52-42VD	159 001 833	Integral 2850 system, 4 to 20 mA output, 10 cell, PVDF ISO threads

Replacement Parts

3-8050-1	159 000 753	Universal mount junction box
3-8052	159 000 188	3/4 in. Integral mounting kit
3-9000.392-1	159 000 839	Liquid-tight connector kit, one set, 1/2 in. NPT
3-9000.392-2	159 000 841	Liquid-tight connector kit, one set, PG 13.5
3-9900.396	159 001 701	Angle Adjustment Adapter
5523-0322	159 000 761	Sensor cable (per ft), 3 conductor plus shield



Georg Fischer Signet LLC, 3401 Aero Jet Avenue, El Monte, CA 91731-2882 U.S.A. • Tel. (626) 571-2770 • Fax (626) 573-2057
For Worldwide Sales and Service, visit our website: www.gfsignet.com • Or call (in the U.S.): (800) 854-4090
For the most up-to-date information, please refer to our website at www.gfsignet.com